

Guidance on Implementation Arrangement Mapping

(March 2017)

Update coming

This document will be updated in 2019 for the 2020-2022 funding cycle.

1 Introduction: Implementation Arrangement Mapping within the Global Fund's Allocation-based Funding Model

All requests for new funding under the allocation-based funding model are required to map out the implementation arrangements of proposed grants. The implementation arrangement maps (IA Maps) are intended to increase transparency around **who** will be doing **what** with **what portion** of grant funds in order to facilitate improvements and introduction of risk mitigation measures into the implementation arrangement during grant negotiation, as well as to strengthen oversight over the entire grant during grant implementation.

The Implementation Arrangement Map is required for each grant¹. Where a grant is a continuation of an existing grant, the existing Implementation Arrangements Map should be updated to reflect any relevant changes.

Under the allocation-based funding model, the implementation arrangements mapping will be used as follows:

During Funding Request Preparation & Grant Making:

- *Funding Request Preparation:* The implementation arrangement can be mapped as soon as it starts to come into focus. In some cases, e.g., if the national health system will be the primary implementation vehicle, or if past grant implementers will be proposed to continue in their existing roles under the new grant, these entities can be mapped early in the funding request preparation stage. In other cases, e.g., where new implementers are going to be selected or significant changes will be made to the existing implementation arrangement, the map may need to be developed over the course of funding request development and grant making.
- *Grant Making:* Implementation arrangement mapping should be continued during grant making as grant implementation details become clearer and additional information are available. The Country Coordinating Mechanism (CCM) and Principal Recipient (PR) are formally responsible for developing and submitting the IA map to the Global Fund Secretariat. However, as the very process of mapping is an effective means of facilitating accurate communication about processes and risks during grant negotiations, so the Country Team and LFA may engage in the mapping exercise jointly with the PR/CCM, in particular in deciding whether multiple grants should be mapped together to demonstrate inter-dependencies.
- *At the end of Grant Making:* Following the capacity assessment and prior to submitting the grant for Board approval, the implementation arrangement map must be updated to reflect any changes and additional information related to implementation arrangements. All outstanding unknowns must be clearly shown on the map as well. The implementation arrangement map will be one of the key grant documents necessary for implementation.

¹ See below for details on mapping for individual grants or several grants within a component.

During Grant Implementation:

- The map should be kept accurate to the actual implementation arrangement. Therefore, the PR should update and re-submit the IA map as and when necessary to reflect changes and additional information on implementation arrangements as they occur.

2 Overview: What is Implementation Arrangement Mapping?

Implementation arrangement mapping is a form of “process mapping,” a best practice methodology used by managers² of complex systems across public³ and private institutions worldwide. Process mapping is recommended as an intuitive, fast, and effective means to (i) attain an accurate understanding of existing processes, (ii) spot areas for improvement such as bottlenecks, redundancies, and weak links, and (iii) institute holistic, reality-responsive change.

In the context of Global Fund grants, an implementation arrangement map is a visual, accurate depiction of a grant (or an entire implementation arrangement of a grant or a program financed by multiple grants), detailing the program’s design and process from receipt of funds to beneficiary-level activity. The map includes: (i) all entities receiving grant funds and/or playing a role in program implementation (regional/district and local offices of the MoH are considered separate entities), (ii) each entity’s role in program implementation, (iii) the flow of funds, commodities, and data, (iv) the beneficiaries of program activities, and (v) any unknowns. Ultimately, an implementation arrangement map should accurately and in detail show **who** is doing **what** with **what proportion** of the grant funds.

3 Methodology: How Is Implementation Mapping Done?

3.1 Mapping a Grant versus a Program

In most cases, a depiction of the implementation arrangement under a single grant will be adequate to accurately depict how a program will achieve its activities, and therefore its objectives. However, there may be cases where a single grant, viewed in isolation, does not accurately depict how program objectives are being met (e.g., dual track financing). In those cases, it may be relevant to include entities and processes financed outside the grant in question, so as to ensure an accurate and thorough picture of reality.

² <http://www.flowmap.com/documents/booklets/dfc.pdf>

³ For health services, see

http://www.institute.nhs.uk/quality_and_service_improvement_tools/quality_and_service_improvement_tools/process_mapping_-_an_overview.html; for medical supply chain, see <http://wpcarey.asu.edu/hsrc-asu/upload/Supply-Metrics.pdf>; for private sector supply chain see <http://www.supplychainquarterly.com/topics/Procurement/scq201102map/>

Since a map should ultimately explain how program objectives are being achieved, in determining the optimal scope of the map, it may be helpful to view the grant from an activity-driven, bottom-up, beneficiary-focused perspective.

3.1.1 Entities should not be ignored –Unknowns can be recorded if Necessary

An organogram that depicts every entity (organization, not person) that plays a role in or receives grant funds in the path from input to activity at the beneficiary level should be visually represented. It is critical that the implementation map not skip entities (e.g., regional and district level offices), bunch entities into generic groups (e.g., health facilities), ignore certain types of entities (e.g., key repeat vendors) or stop short of the beneficiary level (e.g., only PR and SR level). **Rather, if you do not have sufficient information to draw the full implementation arrangement, record what you do not know into the map.** Recording unknowns is critical to track what further information - gathering is needed to obtain an accurate understanding of the actual implementation arrangement.

Map recording “unknowns,” using question marks and grey coloring

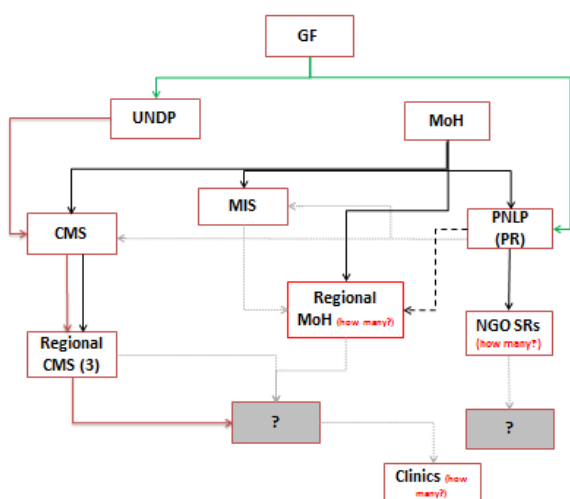

Map without “unknowns”

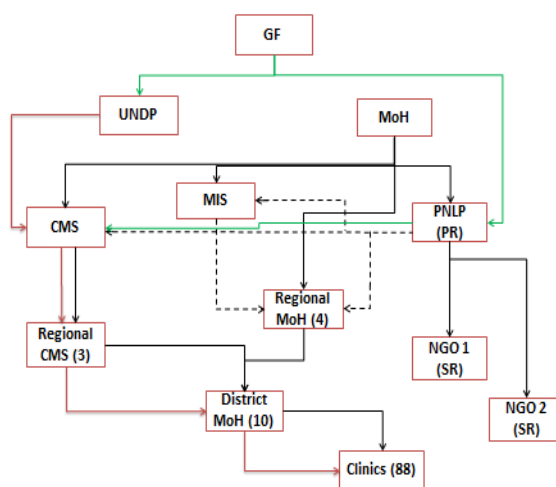

Note that in cases where the same process repeats across multiple districts, grouping may be acceptable as long as the exact process is repeated across the districts. In such a case, noting the number of entities for which the process repeats is acceptable, and a list of the entities and their location (address) should be provided as an annex.

3.1.2 Map Manually First, Then Transfer to Excel or PowerPoint

To easily map the implementation arrangement, give yourself the flexibility to draw it in the simplest, most intuitive way possible. It is usually easiest to first draw the arrangement on paper or a white board, using different colored markers or pens. It may be most efficient to organize a joint mapping session with key implementers who are best informed about the whole of the processes, down to the beneficiary level. Multiple versions can be drawn as the details and ambiguities are clarified. Transfer to a computerized, cleaned-up version can be performed at a later time, to summarize the fruit of the mapping process.



Consider following these practical steps:







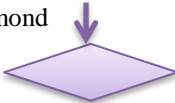

1. Prepare needed supplies: Markers (see proposed legend below); Post-cards or quarter pages; scotch tape or sticky tack; a white board or large paper, a camera.
2. Write the title of the grant(s) being drawn and the date of the exercise on the upper end of the page/board.
3. On each post-card, write the name of each entity (for multiple entities of a similar kind, e.g., district offices, you may put the title of the office and the number of times it repeats)
4. Arrange the entities on the page/board in appropriate relationship to one-another by sticking them on the page/board. You can always adjust the layout of the entities at a later time.
5. With markers, draw relationship arrows between the entities. Record roles and responsibilities and fund/asset flow in this way.
6. Wherever there is an unknown, draw a question mark.
7. Add a legend that accurately reflects the symbols used onto the page.
8. Take a photograph of the map.

Transfer the information onto Excel. The electronic version of the map should be vertical (inputs on top, outputs on bottom). The map should include the grant titles, the size of the grant, the date of the mapping, and a legend that explains the symbols. Regardless, the electronic version should be reader-friendly for any new viewer.

Standardized Symbols in Map

To facilitate reader-friendliness, the electronic version of an implementation arrangement should utilize the following key of symbols:

To map	Draw	Comments
An entity	A box 	Include name of entity, title (PR, SR), and in cases of multiple entities with the same name (e.g., regional offices) provide number of such entities. The colors of the boxes may be adjusted to reflect different entities or grants (e.g., black for implementers of 1 grant, purple for implementers of another, and brown for non-implementers who influence the program).
Beneficiary group	Purple diamond 	At the bottom of the map, include the target beneficiaries/audience. In a purple diamond write the name of the beneficiary group and the population size.
Reporting lines	A black arrow 	Formal authority between entities (not necessarily the authority lines of the implementation arrangement for the grant). Examples include units of the MoH reporting to the Minister of Health.
Coordination lines	A dashed arrow 	Use in cases where one entity is responsible for coordinating/overseeing the performance of another for purposes of the grant, but does not have formal authority over the other. Examples include a PR coordinating with the CMS, or the UNDP as PR overseeing a governmental unit as SR.



Transfer of funds	A green arrow 	Represents money flow (i.e., from Global Fund to PR or procurement agent). This arrow should always prompt for a green circle (see below) to accompany it.
Transfer of assets (HPs)	An orange arrow 	Represents transfer of assets or commodities. This should be principally used to show transfer of Pharmaceuticals or Health Products, but nutritional support may also be represented this way. This arrow should always prompt for an orange circle (see below) to accompany it..
Data Flow	A blue arrow 	Represents flow of M&E data.
Unknowns	Grey box  Grey dotted line 	Grey serves to express unknowns. Entities and relationships can be unknown, etc. Rather than ignoring unknowns, this set of symbols allows parties to record their unknowns concretely, so that they are not forgotten.
Roles & Responsibilities	Free text, as comment in the excel file	Record the roles and responsibilities of each entity in the context of program implementation.
Fund flow	A green circle 	Record % or actual amount of planned budget. NOTE: As implementation begins, the IA map should be annually updated to incorporate proportions of actual funds disbursed to each entity as well: (50%/20%)
Asset flow	An orange circle 	Record % or actual value of planned asset value. NOTE: Actual proportions of funds disbursed should be reflected for assets as well: (50%/43%)
Unknowns	A grey circle 	If you do not know, record this.

When deciding where to place the entities within the space of the map, consider the position of each entity within the hierarchy of the national disease program. Give yourself enough room between entities to incorporate the percentages of money held by each entity and their roles and responsibilities.

Additional Symbols Menu

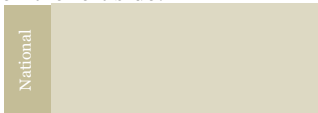
Users have found the following symbols helpful in depicting implementation arrangements as well:

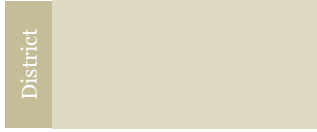
To map	Draw	Comments
Ministry of Health	A background box 	Several organizations may all comprise units of the ministry of health. All of these entities can be mapped over-top and inside a background box (pink) that indicates the ministry of health.
National Level	Light brown band of background across entire map with word “National” on the left side: 	The implementation arrangements extend from national to regional, district and local levels. The entities can be mapped over-top bands that indicate where one level ends to simplify understanding of the system.

Regional Level	Same as above, darker. 	The implementation arrangements extend from national to regional, district and local levels. The entities can be mapped over-top bands that indicate where one level ends to simplify understanding of the system.
District Level	Same as above, lighter. 	The implementation arrangements extend from national to regional, district and local levels. The entities can be mapped over-top bands that indicate where one level ends to simplify understanding of the system.
Local Level	Same as above, darker 	The implementation arrangements extend from national to regional, district and local levels. The entities can be mapped over-top bands that indicate where one level ends to simplify understanding of the system.
Non-grant entity	Rectangle with folded corners 	Other entities, like the CCM, office of the Prime Minister, other donors, etc. also have an influence on the grant. Users are encouraged to indicate these entities as well, and assign different color outlines to the entity depending on entity type.

3.2 Record Roles and Responsibilities

The map also should record the roles and responsibilities of each entity in the context of program implementation. Identifying roles can be performed at the same time as the mapping itself, or as a second step.

The key to this step’s success is to avoid technical jargon so as to ensure that all stakeholders practically understand the roles the same way, and to avoid ambiguities. Rather, roles should be recorded in practical and lay terms, describing exactly what each entity should be doing within the program process. As an example, rather than stating “M&E reporting,” the role should be described as “collects data and reports on number of patients treated.”

It will often be the case that one entity performs multiple roles. In such a case, the map may become overly-crowded with text if use of “lay” terms is used. The details of the roles should therefore be recorded in a table, short-cut phrases used in the visual map. In the final visual, place the roles sufficiently near the entity to facilitate understanding who is responsible for what. Again, if roles are unknown or ambiguous, the map should record this.

3.3 Record Fund and Commodity/Asset Flow

The final step of the mapping is to overlay the organogram with a planned fund and commodity/asset flow. Every step of the process likely entails the transfer of funds and/or assets, and these amounts should be recorded on the map. To preserve space on the map, percentages of the total grant budget can be used, rather than exact amounts. However the exact amounts should be made available in an annex.

Record fund and asset flow on your map by introducing a circle (green for funds, orange for assets) overlaid on top of the line connecting two entities. See the sample diagram below:

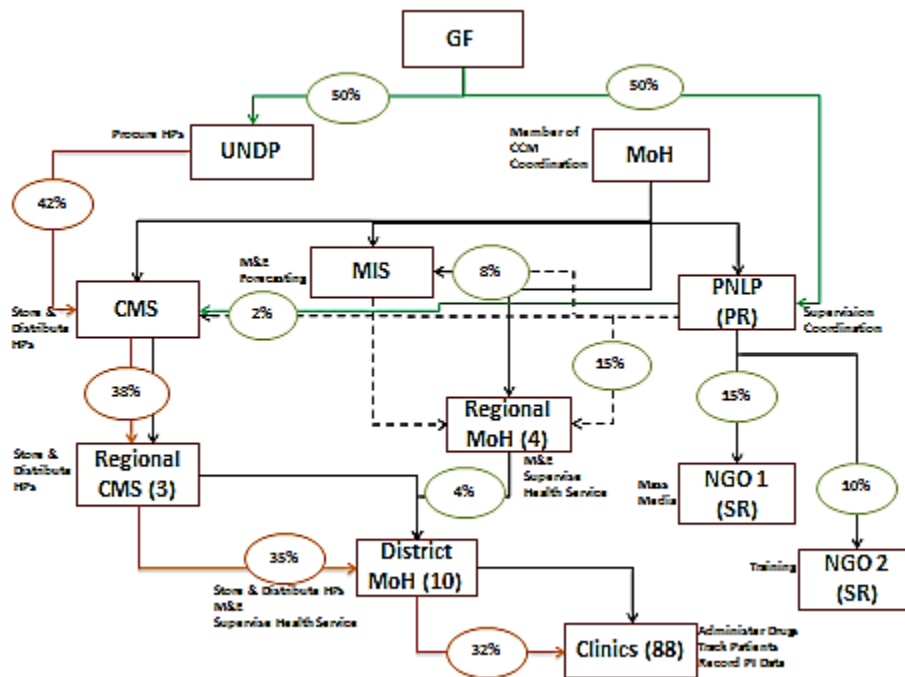

3.4 Ensure that Map Reflects Reality

It is critical that the map not be a reflection of what program leaders think the process is, or what it should be. Rather, the map should seek to reflect what will really be happening on the ground, once implementation commences. During grant negotiation, this can be accomplished through the interplay between the mapping exercise any the systemic assessments. As an initial version of the map will serve to inform the Global Fund’s decisions as to which entities to independently assess from a system standpoint, the findings emerging from this systemic analysis will inform the accuracy of the map.

4 Internal Global Fund Secretariat Use of Implementation Arrangement

The Secretariat uses the IA map to (1) identify “key implementers and (2) rate risk across the implementation arrangement. To achieve a “disbursement ready grant”, as per the OPN on Grant Making and Approval (para 11), the Country Team is required to submit to the GAC an updated, “risk-rated” IA Map. This “risk-rated” map is purely for internal Global Fund Secretariat use and is not shared with the CCM or Implementers.

4.1 Identify Key Implementers

The Global Fund recognizes that the PR alone cannot guarantee grant success, and therefore it looks beyond the PR to identify other implementers that are “key” to a grant’s success. Depending on the need, the Secretariat may focus on these “key implementers” to assess their capacity and propose risk mitigation and supervision approaches to them (See OPN on Access to Funding and Grant-Making, paras 49). The implementation arrangement map helps Country Teams identify key implementers (aside from the PR).

The User Guide to the Capacity Assessment Tool provides guidance on what constitutes a “key” implementer. This assignment is not static—as new information comes to light and priorities change, implementers may be downgraded from “key” and others replaced in reflection of changing risk and prioritization over time.

Implementers may be considered as “key” if:

- *they manage significant portions of the grant funds posing substantial fiduciary risks (e.g. SRs handling more than 50% of grant funds); and/or*
- *they are critical from a programmatic standpoint posing substantial programmatic risks (e.g. SRs implementing risky activities such as trainings; covering a large geographical area, etc.); and /or*
- *they have a track record of weak/unreliable implementation; and/or*
- *the Country Team has insufficient information on the capacity and track record of an implementer that is judged critical for program success and achieving impact.*

The aim is for Country Teams to understand as early as possible in the process (ideally during Funding request development) which entities will be responsible for a significant part of implementation, both from a programmatic and fiduciary standpoints. The identification of key implementers to be assessed (besides the PR) is based on the judgment of the Country Team and the availability of reliable and sufficiently detailed information relating to the proposed implementation arrangements during the time of Funding request development and/or early Grant Making.

To complete the IA Map prior to the submission of grant documents to the GAC, Country Teams are required to mark onto the IA map which implementing entities they have identified as “key”. This should be done by “tagging” the key implementing entity on the IA map with a red star:

